

Bosse

made in Germany



DATA SHEET dialogue cube

TECHNICAL CHARACTERISTICS

- Building-independent, flexible, unfixed setup in the room
- Simple Plug & Play connection to the existing mains electricity via shockproof plug
- Steel frame construction that can be adjusted to uneven floors (maximum height adjustment + 15 mm) with attached white powdered aluminium profiles
- Stable base plate with acoustically effective carpeting and standard floor socket (1x socket, 1x Rj45 connection, optional 2x USB port)
- Practically invisible door hinges, magnetic closure for doors that close quietly
- Interior: acoustic fabric panelling
- Exterior: panelling in a choice of melamine decor or magnetic whiteboard film
- Reverse with composite safety glass including silence film
- Suspended, felt-covered acoustic ceiling, integrated lighting (direct and indirect) and ventilation, optionally available with hanging lights
- Air circulation volume of 320 m³/h, corresponds to approx. 53x air exchange per hour
- Sound level difference between inside and outside of up to 37dB



DIMENSIONS

External width Internal width	2327 mm / 91.6" 2167 mm / 85.3"
External depth Internal depth	1348 mm / 53" 1136 mm / 44.7"
Internal height	2270 mm / 89.4"
External height	2398 mm / 94.4" (room height required on site: 2550 mm)
External panel dimensions	Width: 1241 mm / 48.6" Height: 2398 mm / 94.4"
Internal panel dimensions	Width: 1212 mm / 47.7" Height: 2260 mm / 89"

MATERIALS AND COLOURS

External panel design	Melamine, Whiteboard, Varnish
Internal panel design	Polo acoustic fabric, Divina acoustic fabric, Acoustic photo print Acoustic wood decor Alanda Pine White with function rail
Polo fabric	24 colours: Composition: 100% polyester Weight: approx. 350 g/m, width: 140 cm Light fastness: Grade 6 (EN ISO 105-B02) Friction resistance: wet: 4 – 5 / dry: 4 – 5 Abrasion resistance: 150,000 revolutions (Martindale; EN ISO 12947) Fire behaviour: DIN EN 1021-1/2
Divina fabric	12 colours: Composition: 100% pure wool Weight: approx. 820 – 840 g/lin. m, width: 150 cm Light fastness: Grade 5 – 7 (EN ISO 105-B02) Abrasion resistance: 45,000 revolutions (Martindale; EN ISO 12947) Fire behaviour: DIN EN 1021-1/2
Netting difficult to ignite (optional)	Standard colour: White Composition: 100% Trevira CS (BI) Weight: approx. 53 g/m ² Trevira type designation: 691
Netting difficult to ignite and acoustic (optional)	Standard colour: White Composition: 91% polyester Trevira CS (BI), 9%pPolyester Weight: approx. 110 g/m ² Jazz Dellilight: 35368
Acoustic carpeting	Xerra T-Sonic Backing: bitumen acoustic felt Surface weight: approx. 5400 g/m ² Fire behaviour: Cfl-s1 (BI) Sound absorption level: alpha w 0.30
Fabric colours	Polo: Kashmir White, Cappuccino, Chocolate Brown, Honey Yellow, Orange, Copper Red, Ruby Red, Chilli Red, Shiraz Red, Violet, Aubergine, Royal Blue, Light Blue, Purple, Water Blue, Standard Blue, Night Blue, Dark Green, Light Green, Green, Irish Green, Platinum Grey, Grey and Black Divina: Platinum, Grey, Cappuccino, Green, Turquoise, Indigo Blue, Pink, Curry Yellow, Pepper Brown, Anthracite Grey, Black, Irish Green and Water Blue
Colour finishes	Melamine: White, Winter White Cream, Grey, Silver, Congo, Volcanic Grey, Melamine Grey, Anthracite, Volcanic Black and Black Wood decors: Maple, Light Oak, Walnut and Alanda Pine White
Glass	Composite safety glass 12.76 mm with silence film

CONSTRUCTION

Ceiling	Acoustically effective felt-covered perforated sheet cover, including ventilation and lighting
Skeleton and element profile	Free-standing black steel frame construction
Floor seal/Floor connection	Plinth with carpet cladding
Door	Revolving door made of 10 mm safety glass (ESG), practically flush/invisible door hinges, silent magnetic closure (not lockable)

TECHNICAL

Electrification	1x on-site power connection (120V/60Hz - 230V/50Hz) for control box (control of the direct/indirect illumination, ventilation, presence sensor and sockets); light and air are operated via a motion sensor built into the standard version
Ventilation	Building-independent ventilation of the product by silent fans. Air exchange performed with ambient air. Air intake via the base, air output behind the suspended ceiling panel. Ventilation principle: <ul style="list-style-type: none">• Two silent fans remove the used air from the product• Power consumption per fan: 1.44 W• Revolutions per fan: 1450 rpm• Noise level per fan: 16.4 dB• Output volume per fan: 80 m³/h• Total air exchange: approx. 60x per hour
Direct illumination	Four flush-mounted high power LED light dots in the suspended ceiling panel. <ul style="list-style-type: none">• Power consumption: 10.3 W• Light colour: 3000 K• Protection class: IP 20• Light flux: approx. 750 lm• Energy efficiency class: A+• Light distribution: 100% direct beam
Indirect illumination	An LED strip incorporated into the ceiling panel provides indirect illumination. <ul style="list-style-type: none">• Power consumption: 5 W/m• Light colour: 2700 K - 3000 K• Protection class: IP 20• Light flux: max. 330 lm
Hanging lights (optional)	Felt hanging light Ø300mm 250 mm high, white felt interior, grey felt exterior, 12 V bulb, 8 W LED, 3000 K, E27. Connection via standard socket in recessed ceiling panel
Presence sensor	The presence sensor integrated into the ceiling controls the illumination and ventilation with a factory-set follow-up time of two minutes. The wireless remote control allows you to set the follow-up time, light sensitivity, etc. <ul style="list-style-type: none">• Operating current: 110 – 240 V DC• Brightness adjustment range: 5 – 1000 lx• Light & air follow-up time: 30 sec. – 30 min.• Protection class: IP 21 (sensor), IP 20 (power unit)
Total power consumption	approx. 38 W
Total power connection of fitted sockets	maximum 3 kW

ACOUSTICS/SOUND

Sound tightness between inside and outside (standard sound level difference DnT)	Sound insulation value of up to 37 dB. The measured value relates to the finished assembled dialogue cube 2.0.
--	---

EC DECLARATION OF CONFORMITY

With the EC declaration of conformity, Bosse Design Gesellschaft für Innovative Office Interiors mbH & Co. KG confirms that the human space cube HSC2018 meets the fundamental health and safety requirements of all relevant European guidelines, i.e. conforms to these guidelines.

DIMENSIONS

STANDARD PANEL DIMENSIONS

Interior	Width: 1212 mm / 47.7" Height: 2260 mm / 89"
Exterior	Width: 1141 mm / 45" Height: 2398 mm / 94"

STANDARD CUBE DIMENSIONS

Interior	Width: 2167 mm / 85.3" Depth: 1218 mm / 48" Height: 2270 mm / 89.4"
Exterior	Width: 2327 mm / 91.6" Depth: 1348 mm / 53" Height: 2398 mm / 94"
Room height required on site	2550 mm / 100.4"

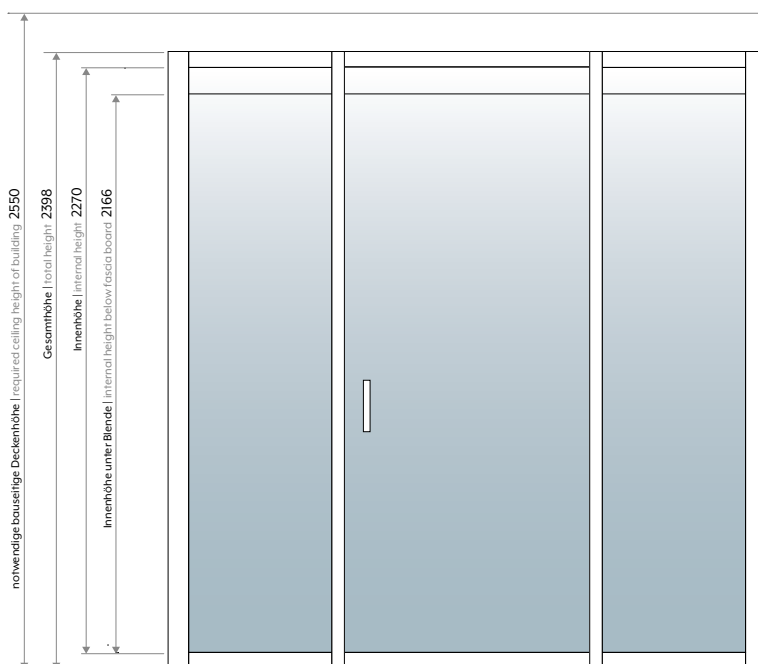
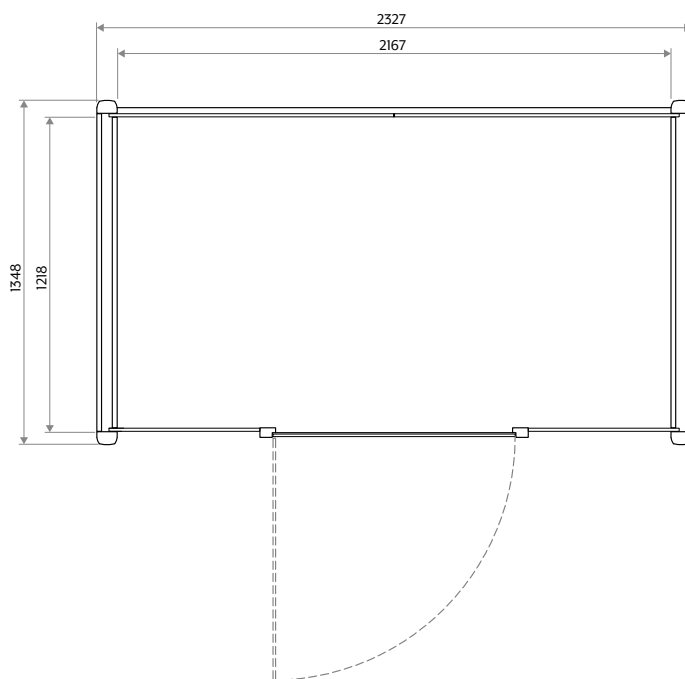

SECTION DRAWINGS

Melamine



Whiteboard

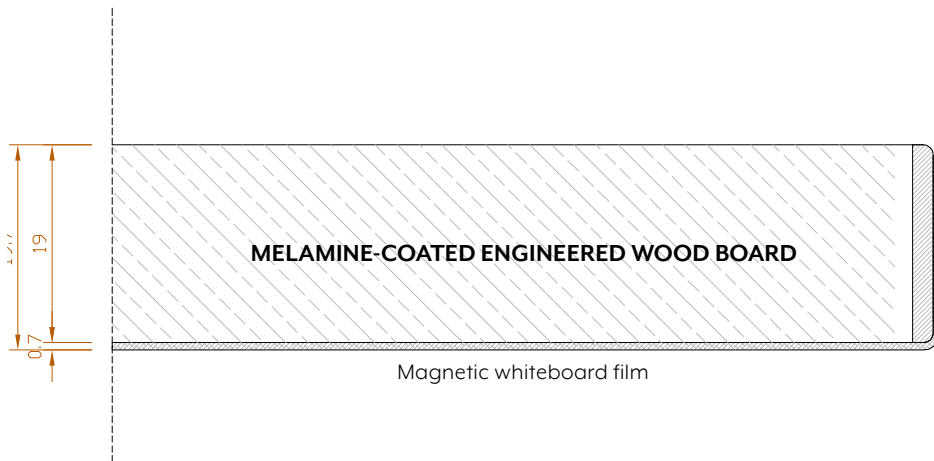

Varnish



SECTION DRAWINGS

Acoustic Polo/Divina

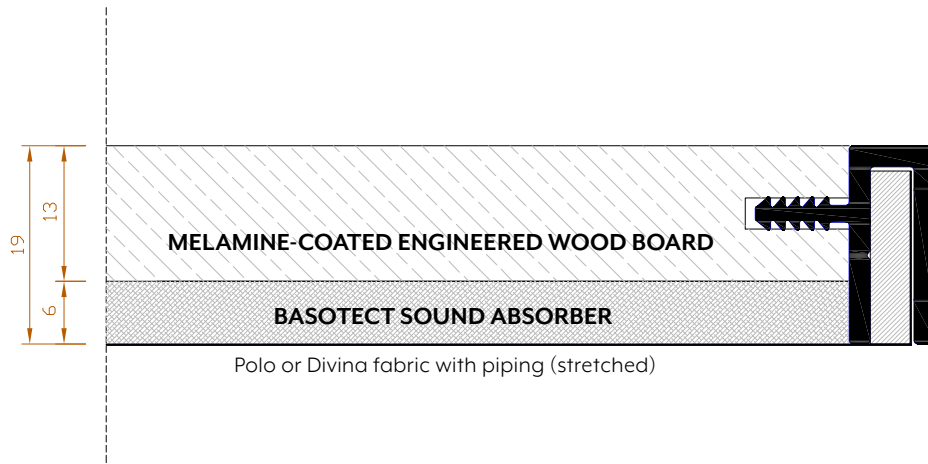

Acoustic photo print

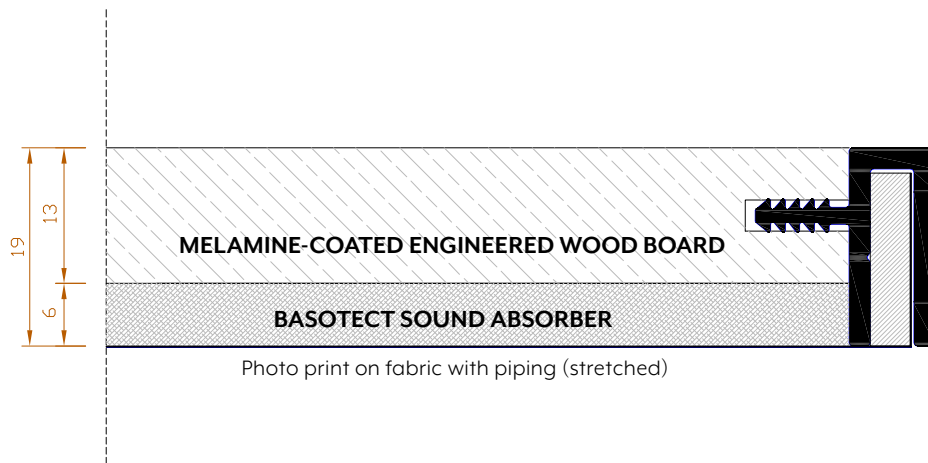

FABRICS

POLO FABRIC

Composition: 100% polyester

Weight: approx. 350 g/m, width: 140 cm

Light fastness: Grade 6 (EN ISO 105-B02)

Friction resistance: wet: 4 – 5 / dry: 4 – 5

Abrasion resistance: 150,000 revolutions

(Martindale; EN ISO 12947)

Fire behaviour: DIN EN 1021-1/2



7703 (4650) *
Honiggelb | Honey yellow



7744 (4613)
Orange | Orange



7745 (4612)
Kupferrot | Pure copper



7711 (4633)
Hellgrün | Vivid green



7712 (4632)
Irischgrün | Irish green



7710 (4631)
Grün | Organic green



7740 (4610)
Chillirod | Chili red

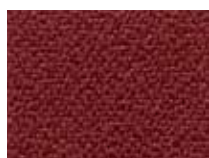

7742 (4614)
Rubinrot | Rubin red



7748 (4611)
Shirazrot | Shiraz red



7772 (4642)
Kaschmirweiß | Cashmere



7750 (4641)
Cappuccino | Cappuccino



7760 (4640)
Schokobraun | Chocolate

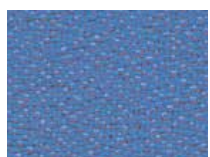

7725 (4625)
Wasserblau | Lagoon blue



7726 (4624)
Purpur | Purple



7720 (4621)
Standardblau | Classic blue



7731 (4602)
Platingrau | Platin



7730 (4601)
Grau | Metal grey



7733 (4600)
Schwarz | Midnight black



7727 (4626)
Königsblau | Royal blue



7729 (4620)
Nachtblau | Midnight blue

DIVINA FABRIC

Composition: 100% polyester

Weight: approx. 350 g/m, width: 140 cm

Light fastness: Grade 6 (EN ISO 105-B02)

Friction resistance: wet: 4 – 5 / dry: 4 – 5

Abrasion resistance: 150,000 revolutions

(Martindale; EN ISO 12947)

Fire behaviour: DIN EN 1021-1/2



3231
Platingrau | Platin



3250
Cappuccino | Cappuccino



3210
Grün | Organic green



3223
Türkis | Caribbean blue



3219
Indigo Blau | Indigo blue



3246
Pink | Pink orchid



3204
Currygelb | Curry yellow



3262
Pfefferbraun | Brown Pepper

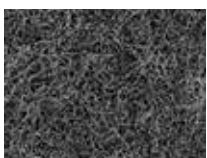

3236
Anthrazitgrau | Asphaltgrey



3233
Schwarz | Midnightblack

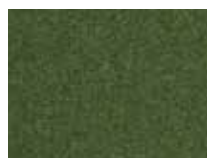

3212
Irischgrün | Irish green



3225
Wasserblau | Lagoon blue

SURFACES

UNIDEKORE | PLAIN FINISHES

für Frontseiten der Fix- und Flexpaneele sowie der Außenpaneele für telephone cube 2.0 und dialogue cube 2.0 | For fronts of the fixed and flex panels as well as the outside panels for telephone cube 2.0 and dialogue cube 2.0

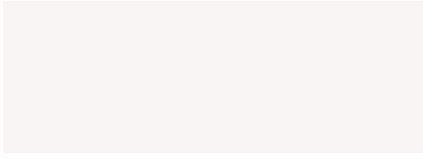

Weiß | White

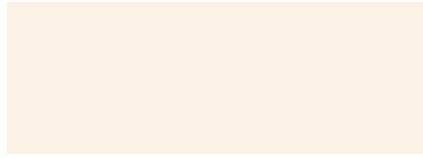

Creme winterweiß | Creme winter white



Grau | Grey



Silber | Silver



Congo | Congo



Vulkangrau | Volcano grey



Anthrazit | Anthracite



Vulkanschwarz VV | Volcano black VV

HOLZDEKORE | WOOD FINISHES

Für Frontseiten der Fix- und Flexpaneele sowie der Außenpaneele für telephone cube 2.0 und dialogue cube 2.0 | For fronts of the fixed and flex panels as well as the outside panels for telephone cube 2.0 and dialogue cube 2.0



Ahorn | Maple



Eiche hell | Light oak

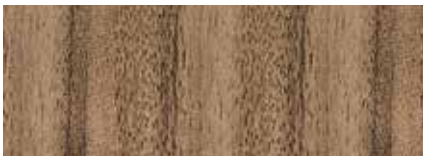

Nussbaum | Walnut

PHOTO PRINT



FOILING



AIR EXCHANGE RATE

Room volume calculation

Length (2.17 m) x width (1.22 m) x height (2.27 m) = room volume (6.01 m³)

Air output volume

Output volume per fan (80.47 m³/h) x number of fans (4 units) = total air output volume (321.88 m³/h)

Total air exchange

Air output volume (321.88 m³/h) / room volume (6.01 m³) = total air exchange (approx. 53x per hour)

Air exchange calculation per number of people in the room:

Average air volume per person (25 m³/h) x number of people (1) = air exchange rate (25 m³/h)

Average air volume per person (25 m³/h) x number of people (2) = air exchange rate (50 m³/h)

Average air volume per person (25 m³/h) x number of people (3) = air exchange rate (75 m³/h)

Average air volume per person (25 m³/h) x number of people (4) = air exchange rate (100 m³/h)

Average air volume per person (45 m³/h) x number of people (1) = air exchange rate (45 m³/h)

Average air volume per person (45 m³/h) x number of people (2) = air exchange rate (90 m³/h)

Average air volume per person (45 m³/h) x number of people (3) = air exchange rate (135 m³/h)

Average air volume per person (45 m³/h) x number of people (4) = air exchange rate (180 m³/h)

A (Air exchange rate)

A1 (the average air volume per person, m³/h)

NP (number of people in the room)

20 to 25 m³/h per person during minimal physical activity

45 m³/h per person during light physical activity

VENTILATION PRINCIPLE

The building-independent ventilation principle of the Telephone cube is based on air exchange with ambient air. This is drawn in from below (front and back). The air flows upwards under the panels (both sides) and is removed from the Telephone cube.

This circuit generates continuous air circulation and ensures the best possible room climate. The ventilation system is low-noise and energy-efficient.

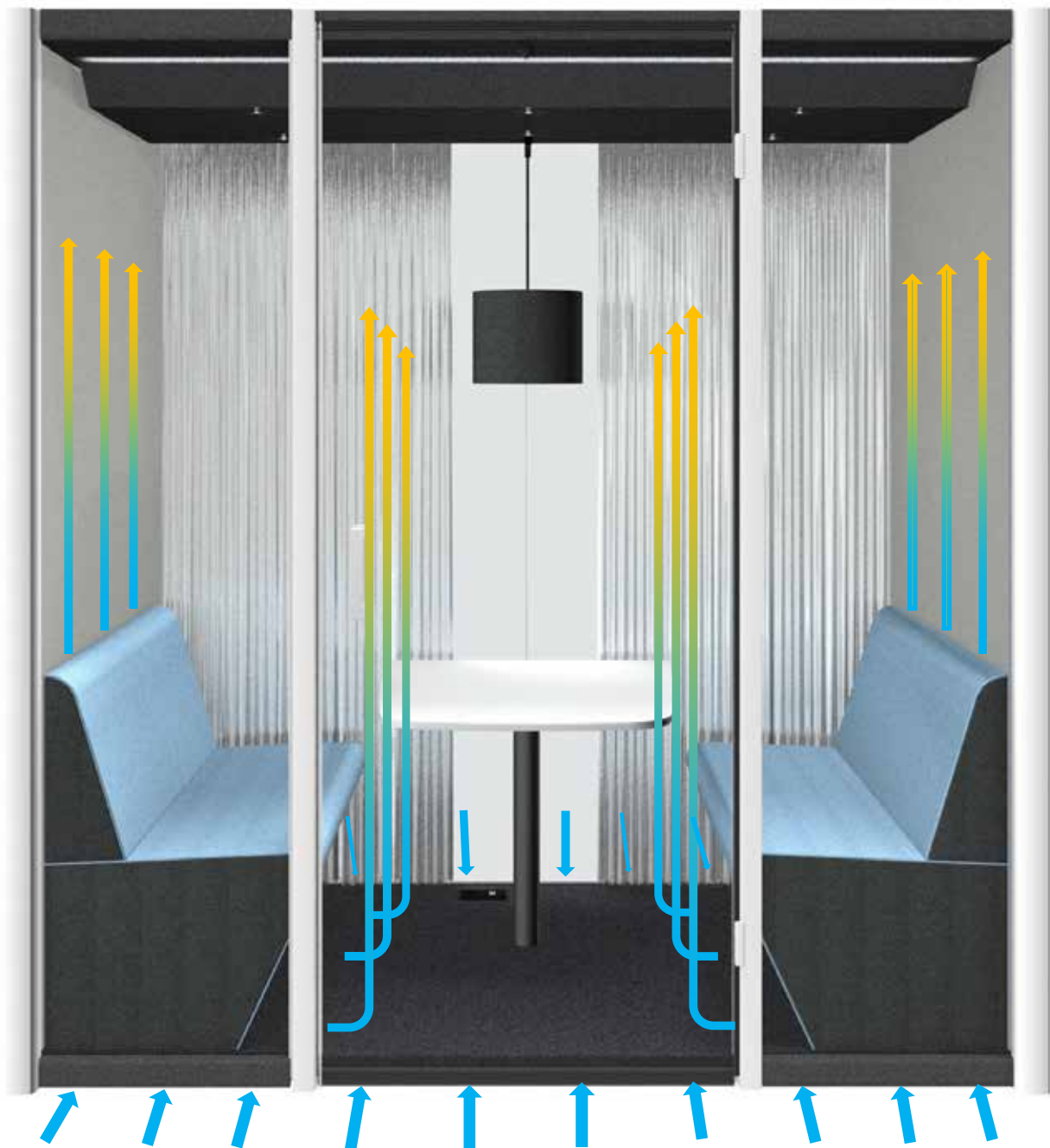

EG-Konformitätserklärung im Sinne der EG-Richtlinien



Wir, die Firma Bosse Design
Gesellschaft für Innovative Office Interiors mbH & Co. KG
Stahler Ufer 7
D-37671 Höxter

erklären hiermit, in alleiniger Verantwortung, dass die nachstehend bezeichneten Produkte

Produkt / Gerätetyp	Typenbezeichnung	Artikel-Nr.
Schallisolierter Besprechungsraum	BOSSE telephone cube 2.0	TC2018 - B [mm] x T [mm] B (Breite außen) = 1210 T (Tiefe außen) = 1248 H (Höhe außen) = 2398 Sondermaße möglich
Schallisolierter Besprechungsraum	BOSSE dialogue cube	DC2018 - B [mm] x T [mm] B (Breite außen) = 2327 T (Tiefe außen) = 1348 H (Höhe außen) = 2398 Sondermaße möglich

in ihrer Konzeption und Bauart sowie in der von der Bosse Design Gesellschaft für Innovative Office Interiors mbH & Co. KG in Verkehr gebrachten Ausführung mit den grundlegenden Anforderungen der folgenden Richtlinien und Normen übereinstimmen⁽¹⁾.

Richtlinie	
2014/35/EU	Niederspannungsrichtlinie
2014/30/EU	EMV-Richtlinie
2001/95/EG	Produktsicherheit
2011/65/EU	RoHS
2012/19/EU	Elektro- und Elektronik-Altgeräte (WEEE)

Die oben genannte Firma hält die erforderliche technische Dokumentation zur Einsicht bereit.

Höxter, den 17.07.2019



Andre Heuer
Geschäftsführer

Anmerkungen:

- 1) Diese Konformitätserklärung verliert ihre Gültigkeit, wenn das Produkt ohne ausdrückliche Zustimmung der Bosse Design Gesellschaft für Innovative Office Interiors mbH & Co. KG umgebaut, ergänzt oder in sonstiger Weise verändert wird, wenn Bauteile, die nicht zum Originalzubehör der Bosse Design Gesellschaft für Innovative Office Interiors mbH & Co. KG gehören, in das Produkt eingebaut werden, sowie bei unsachgemäßem Anschluss oder nicht bestimmungsgemäßer Verwendung.

bossecube.com
dauphin-group.com

Manufacturer:

Bosse Design Gesellschaft für
Innovative Office Interiors mbH & Co. KG
Stahler Ufer 7
37671 Höxter/Stahle, Germany
+49 5531 1297-0
info@bosse.de

Distribution:

Dauphin HumanDesign® Group GmbH & Co. KG
Espanstraße 36
91238 Offenhausen, Germany
+49 9158 17-700
info@dauphin-group.com

Bosse